

The **PERGAMEAN** Church Age 60-1207

3rd

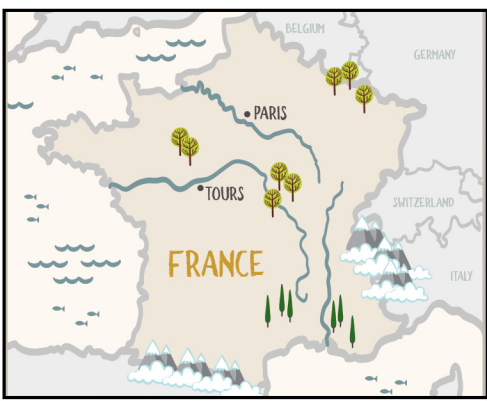

deeds noun
 • an action that is performed intentionally or consciously

doctrine noun
 • a belief (or system of beliefs) accepted as authoritative by some group or school

...became a **doctrine** in the Pergamos church."
 60-1205 paragraph 146

Nicolaitanes

"What was **deeds** in Ephesus..."



Now listen closely, my children.

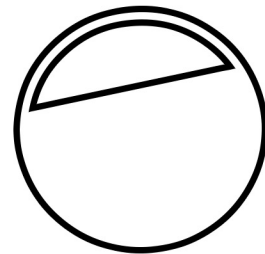

Pergamos

Doctrine of Balaam

a person who is killed because of their religious beliefs

Joining the church spiritual with the church natural

Martyr

means: Married

Pergamean 312-606



312

**Pergamos Age
starts**



315

**Martin is
born in
Hungary**

Nicene Council



325

**"That's when they
formed the first
organization, which
was the Catholic church."
59-0823**



354

**Augustine of
Hippo decrees
Christians to die**



399

**Martin goes
home to be with
the Lord**



606

**Pergamos
Church
Age ends**



**that
together”**

**“Let’s
say**

**“What
you
do to
others,**



**you have
done it
to
Christ.”**

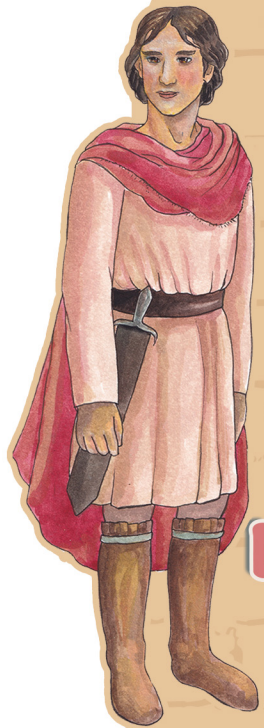

THE LIFE OF
Saint Martin was...
IS ONE OF
THE GREATEST
miracle-filled
LIVES OF ANYBODY IN
THE CHURCH AGES.

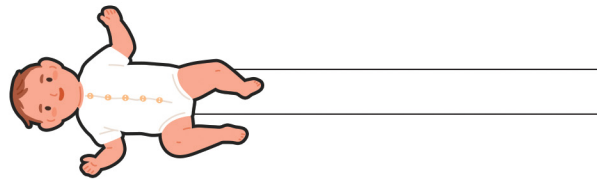
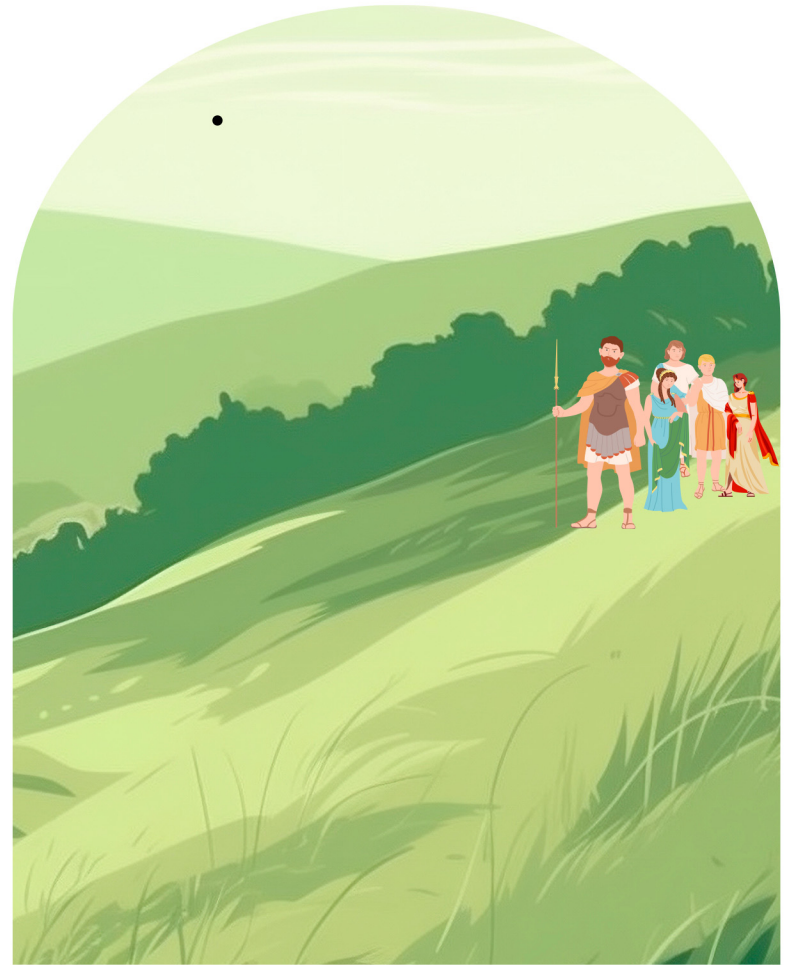

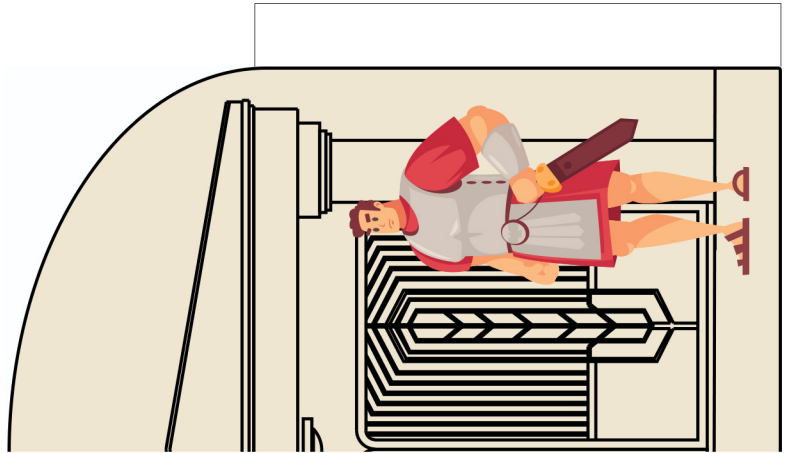
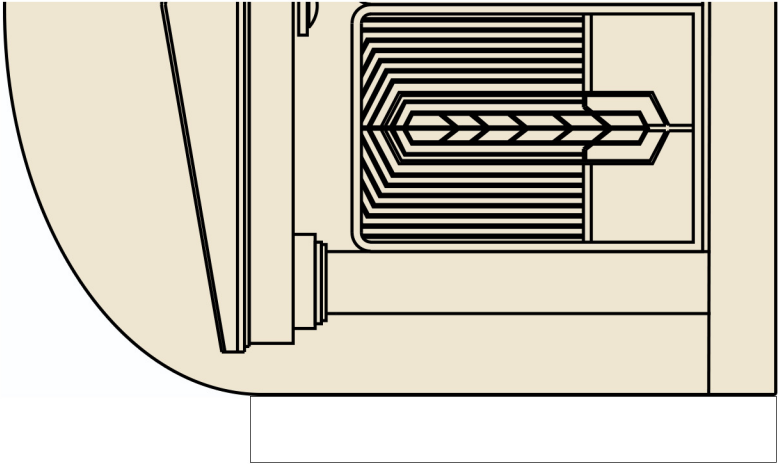
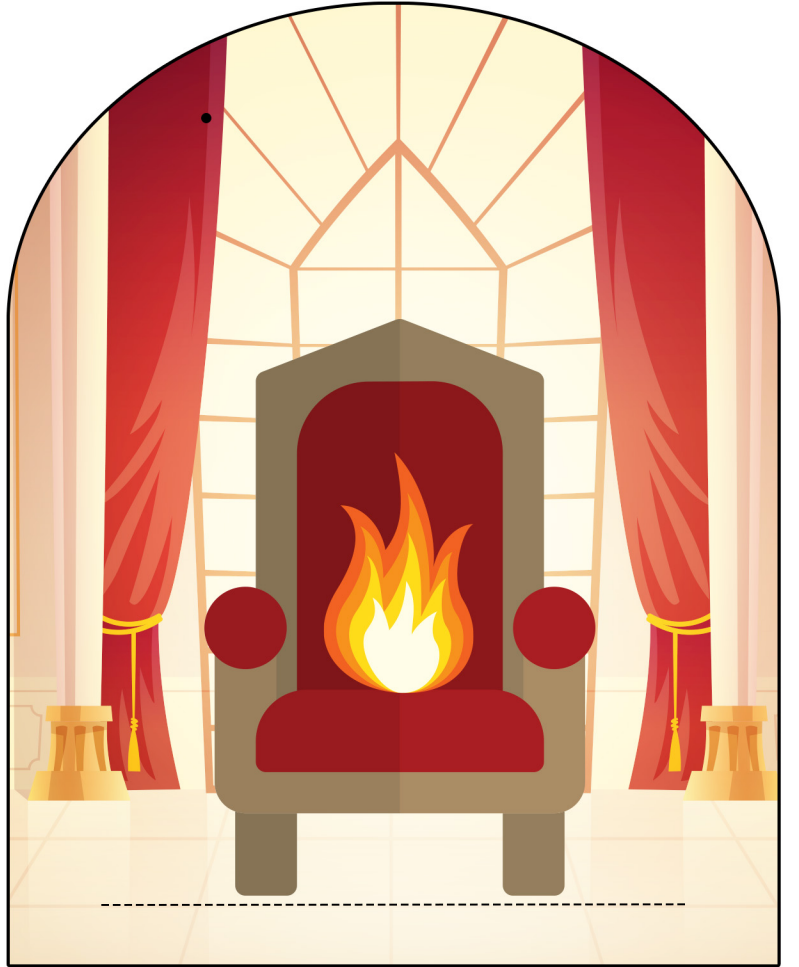

Revelation
2:12-17

SALUTATION

12 And to the angel of the church in **PERGAMOS** write; These things saith

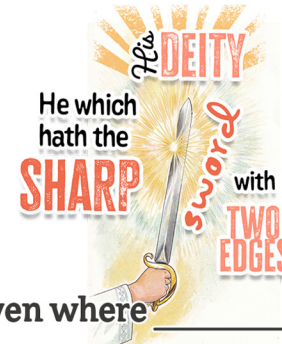

13 I know thy works, and where thou dwellest, even where _____ is: and thou holdest fast my _____, and hast not denied my faith, even in those days wherein _____ was my faithful _____, who was slain among you, where Satan dwelleth.

1

“Well the Sword is the **“WORD.”**

Hebrews 4, we took it in the beginning when we run that **DEITY** of Him down.”

The sword, we found in

Hebrews 4:12

“THE WORD OF GOD WAS SHARPER THAN A TWO-EDGE SWORD.”

Is that right? That was the Word of God. Is it...? There now watch, you- ha- **get these**

interpretations.

2

Now Trace that

Word,

Saint John 1,

“In the beginning”

(way back)” was the

that

created the heavens and earth.”

Is that right? “And the Word was with God, and the Word was **DEITY**. And **DEITY WAS MADE FLESH AND DWELLED AMONG US...”**

Pro Benham

COMPLAINT

14 But I have a few things _____, because thou hast there them that hold the _____ of _____, who taught Balac to cast a stumblingblock before the children of Israel, to eat things sacrificed unto idols, and to commit fornication.

15 So hast thou also them that hold the _____, which thing **I HATE.**

3

16 **“Repent;**

or else I will come unto thee quickly, and will fight against them with the sword of My mouth.”

4

Reward

To him that overcometh will I give _____,

to eat of the _____,

and will give him a _____,

and in the stone a new name written, which no man knoweth saving he that receiveth it.

17

He that hath an ear, let Him Hear what the Spirit saith unto the Churches;

5

